

User Manual

Professional Automotive Circuit Tester

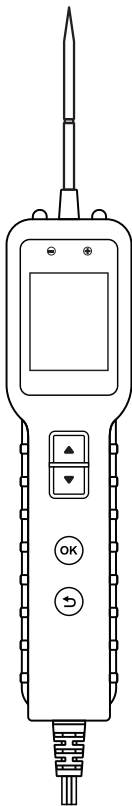

Catalog

Precautions	01
1. Product Overview	02
1.1 Panel Parsing	03
1.2 Parameter Information	04
2. Product Features	04
2.1 Multimeter	04
2.1-1 Voltage Test	05
2.1-2 Resistance Test	05
2.1-3 Diode Test	06
2.1-4 ON/OFF Test	06
2.1-5 P-N Test	07
2.1-6 Frequency	08
2.1-7 Oscilloscope	09
2.2 Component Activation	09
2.3 Settings	11
2.3-1 Languages	11
2.3-2 Self-test Function	11
2.3-3 LED light/Buzzer Switch	12
2.3-4 Information	12
3. Warranty and Service	13



Product Overview

This manual includes instructions for using the equipment and operation methods, in order to prevent personal injury and damage to the vehicle or fault diagnostic instrument, please read this user manual carefully first, and observe the following safety precautions when operating the vehicle:

- Please test in a safe environment.
- Do not attempt to operate or observe the tool while driving the vehicle. Operating or observing the tool can cause distraction to the driver and can lead to fatal deaths.
- Keep clothing, hair, hands, tools, test equipment, etc. away from all moving or high-temperature engine parts.
- If there is a malfunction of the instrument (e.g., if it is found that it is damaged, deformed, leaking material, incomplete display, etc.), it cannot be used again.
- Wear safety goggles that comply with ANSI standards.
- Due to the different product versions, the description of the manual, the interface icon, and the interpretation of the icon will be slightly different, so it is hereby explained.

1. Product Overview

This equipment is suitable for 0V~80V automotive circuit tester, this circuit tester is well designed, easy to operate, contain complete functions. The device equips TFT high-resolution color screen, test process and results can be intuitively and clearly displayed on the TFT screen. It helps users understanding vehicle problems faster and more accurately, it is an efficient and advanced testing tool, which can greatly improve the user's work efficiency.

Main functions: Voltage Test/Resistance Test/Diode Test/P-N Test/Frequency/Component Activation.

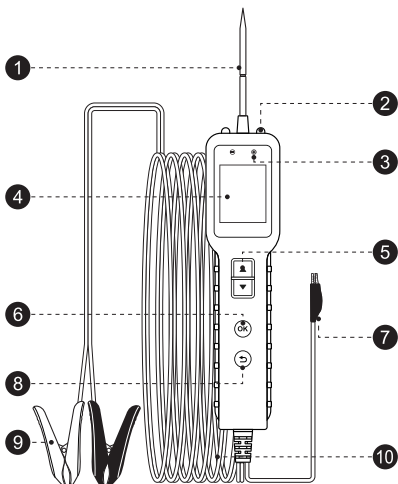

1. 1 Panel Parsing

- 1 **Probe:** Contact wires or elements for testing (Can be disassembled).
- 2 **LED Lights:** provide illumination in dark.
- 3 **LED Indicator:** Provide light prompt during the test.
- 4 **Display:** 1.8 inch TFT true color screen.
- 5 **Up/Down Buttons:** Used to adjust the value in the selection interface, realize the page turning function or the output of the positive and negative.
- 6 **OK Key:** Confirm the selection, press enter.
- 7 **Ground Clip:** Grounding wire auxiliary test function.
- 8 **Back Key:** Undo or return to the previous page.
- 9 **Battery Clips:** Connect the battery to power the device.
- 10 **Test Cable:** 5 meters main cable.

1. 2 Parameter Information

Project	Description
Input Voltage	8V ~ 32V
Test Voltage	0V ~ 80V
Operating Current	80mA
Activation Current	0 ~ 8A
Operating Temperature	0°C~60°C (32°F~140°F)
Storage Temperature	-40°C~70°C (-40°F~185°F)

2. Product features

2. 1 Multimeter

This device is powered by an external battery or a car battery, connect the red clip to the positive terminal and the black clip to the negative terminal before starting to test the circuit or component.

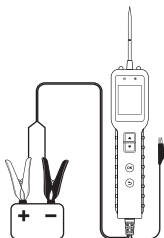

2. 1-1 Voltage Test

Connect the red clip to the positive terminal and the black clip to the negative terminal.

Attach the probe to the positive terminal, the display will read the maximum voltage, minimum voltage.

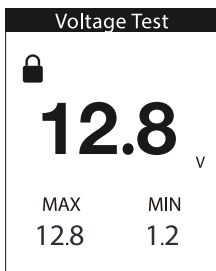

2. 1-2 Resistance Test

Enter the resistance menu: Connect the ground clip (auxiliary grounding wire) to one side of the resistance being measured, attach the probe to the other side, then the device will display the resistance value. (Please turn off the power before entering the resistance test).

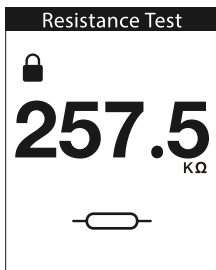

2. 1-3 Diode Test

Connect the ground clip (auxiliary ground lead) to the negative pole of the diode, then attach the probe to the positive pole. The measured value of the diode is displayed.

*If connecting with opposite pole of diode, the voltage value will NOT display.

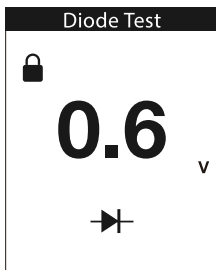

2. 1-4 ON/OFF Test

Connecting the ground clip (auxiliary ground lead) to one side of the resistance while connecting the probe to the other end, screen will display the measured resistance value.

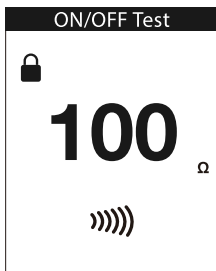

If the resistance value $\geq 100\Omega$, the device will recognize as open circuit, the buzzer is silent; If the resistance value $< 100\Omega$, the device will recognize as have good conductivity, and the buzzer beeps continuously, and the red LED light indication.

2. 1-5 P-N Test

Connect the ground clip to the vehicle's ground wire and use the probe to touch the positive or negative poles of the vehicle's system.

When a positive signal is detected, the positive voltage value and the positive electrode (+) are disp-

layed. When the negative signal is detected, the negative voltage value and the negative electrode (-) are displayed.

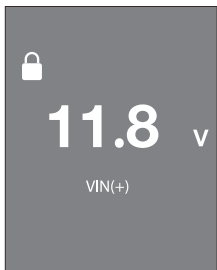

2. 1-6 Frequency

Connect the ground clip to the vehicle's ground clip, use the probe to touch the location to be measured, and the screen will display the frequency, duty cycle of the measured signal.

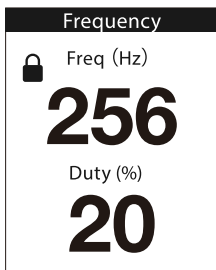

2. 1-7 Oscilloscope

Enter the oscilloscope mode, the current signal waveform will be displayed, "MAX" is the maximum value, "MIN" is the minimum value, "Freq" is the frequency, "Duty" is the duty cycle, press the "OK" button to lock the current display waveform, which is convenient for comparison and observation of the waveform.

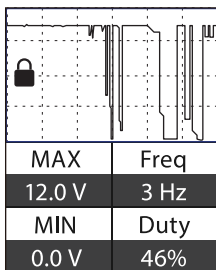

Note: In both multimeter mode and oscilloscope mode, press the "OK" key to lock the current display interface.

2. 2 Component Activation

The activation function can be used to activate components such as starter, fuel pumps, solenoid valves, blowers, cooling fans, headlights, etc.

Connect the grounding clip to the negative pole, connect the probe to the positive pole, press the "Up" button, the probe will output a positive voltage, and display the voltage value at the same time, the buzzer will beep continuously, the red LED light on the screen will light up. The test part will be activated.

The probe can output both positive and negative voltages. Press the "Up" button, the probe will output a positive voltage, the red LED light will light up, and the voltage value will be displayed on the screen at the same time. Press the "Down" button, the probe will output a negative voltage, the green LED light will light up, and the buzzer will sound. The maximum activated output current is 8A, if it exceeds 8A, the trip protection function will be activated, the device will be restarted.

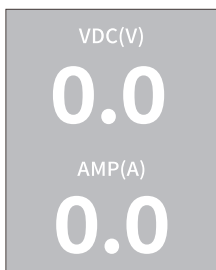

2. 3 Settings

2. 3-1 Languages

You can choose 12 languages such as Chinese Simplified, English, French, and German, etc. in settings.

Languages
中文简体
English
Français
Русский
Deutsch
Italiano
Espanol
Português

Languages
日本語
中文繁體
Polski
Czech

2. 3-2 Self-test Function

Self-test the unit screen, LED lights, and buzzer.

Hardware Self-test
LCD Self-test
LED Self-test
Buzzer Self-test

2. 3-3 LED light/Buzzer Switch

Set the buzzer and flashlight on/off.

Beep
ON
OFF

Flashlight
ON
OFF

2. 3-4 Information

View the local device information

Information
S/N:YH1011CT200
HW WER:V1.0
SW WER:V1.0
DATE:11/10

3. Warranty and Service

Hello! Thank you for purchasing our product. In order to better serve you, please read this warranty card carefully, fill it out correctly and save it.

Name			
Telephone			
Email			
Purchase Date		Product Number	
Order Number			
Shipping Address			
Maintenance Records	Date	Failure Causes and Solutions	

※ **Warranty Statement:**

If the product requires warranty due to quality problems, please send it back to us together with this warranty card.

Manufacturer

OBDResource Electronics Co., Ltd

Email: info@obdresource.com

Tel: +86-755-29071623

Web: www.obdresource.cn

Add: Xinniu Community, Longhua District,
Shenzhen, CN



EVATOST CONSULTING LTD

Suite 11, First Floor, Moy Road Business
Centre, Taffs Well, Cardiff, Wales, CF15 7QR
contact@evatmaster.com

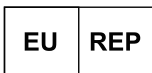

SUCCESS COURIER SL

CALLE RIO TORMES NUM.1, PLANTA 1, DERECHA
OFICINA 3, Fuenlabrada, Madrid, 28947 Spain
successservice2@hotmail.com

EU001721038211949SOf0

